

ARIES PC/104-Plus SBC with Intel E3800 CPU, Soldered RAM, & On-Board Data Acquisition

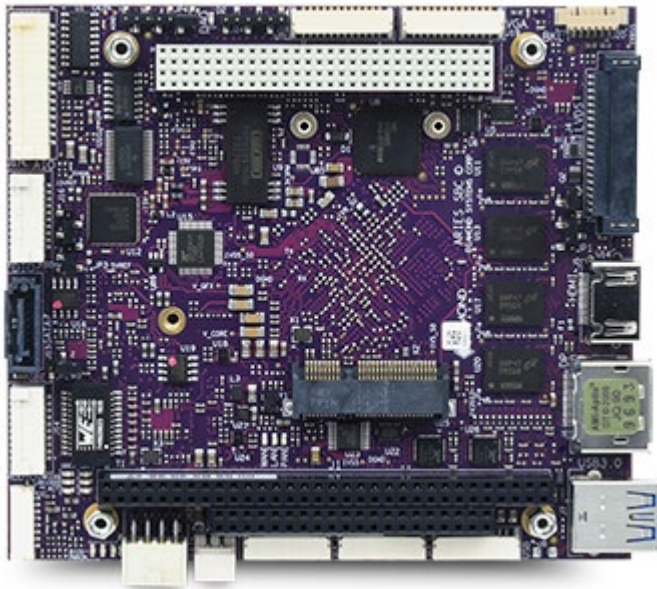

DIAMOND
SYSTEM



FEATURES

1.91GHz Intel quad core E3845
or
1.46GHz Intel dual core E3826
CPU

2GB or 4GB on-board 64-bit
DDR3 SDRAM

I/O connectors for a wide range
of interfaces:

- 2 Gigabit Ethernet ports
- 1 SATA port
- 3 USB 2.0 & 1 USB 3.0 port

On-board data acquisition
circuit:

- 16 16-bit analog inputs
- 4 16-bit analog outputs
- 22 digital I/O lines

& nbs

Rugged design:

- Thicker PCB
- Latching I/O connectors
- Conduction cooling heat spreader

On-board mSATA flashdisk
socket supports up to 64GB

Watchdog timer

+5VDC input power

System expansion:

- PC/104-Plus stackable I/O
- PCIe MiniCard socket

4.0"H x 4.5"W form factor

Operating temperature range of
-40°C to +85°C

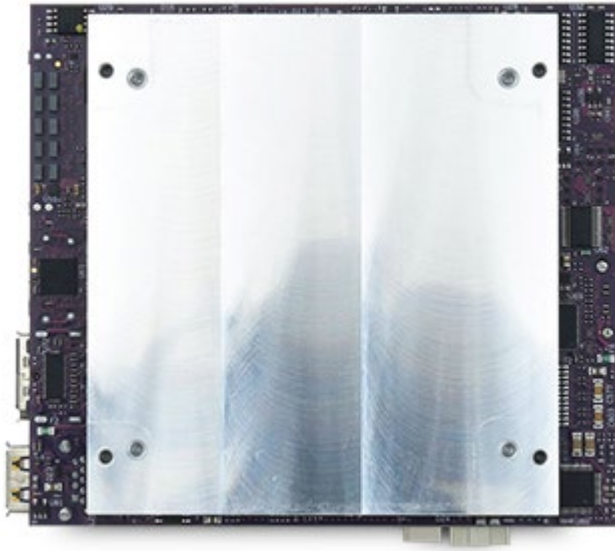

Bottom side showing heat spreader mounting plate

◆ Description

The **Aries** PC/104-Plus single board computer from Diamond Systems uses the Intel "Bay Trail" E3800 series processor to deliver an unmatched combination of performance, price and power consumption. Packed with real-world features, Aries provides a complete solution for most embedded applications in a single board, saving you space, time, and money.

Aries goes beyond the standard processor and I/O features found on other Bay Trail SBCs to provide rugged performance along with a professional-quality data acquisition circuit supported by industry-leading software. The full rectangular shape of Aries provides more PCB area and coastline to support the extreme level of I/O offered by the board.

Software support for Aries includes Linux, Windows 7, Windows 10, and QNX Neutrino 7.0. Software support includes downloadable drivers as well as complete ready-to-run board support packages (BSPs) preprogrammed onto a solid state flashdisk that installs directly onto the board. Demo programs for the integrated data acquisition circuit are included in the runtime image. Simply install the flashdisk, apply power, and you are up and running.



◆ Overview

The Aries SBC family features the Intel E3800 "Bay Trail" processor family for high performance, low power consumption, and competitive pricing. Aries offers 2-4 times higher CPU performance over other SBCs with similar size, power consumption, and price. Key features include:

- Choice of quad core E3845 1.91GHz or dual core E3826 1.46Ghz processor
- 2 or 4GB memory soldered on board
- Dual independent display, selectable from VGA, LVDS LCD, and HDMI / DisplayPort
- A broad range of system I/O, including 4 multiprotocol serial ports, 3 USB ports, 2 10/100/1000 Ethernet ports, and 1 SATA port
- Integrated HD Audio
- PC/104-Plus and PCIe MiniCard / mSATA sockets
- Optional integrated professional quality 16-bit data acquisition
- Conduction cooling for improved reliability and high temperature performance
- Rugged construction throughout for shock and vibration immunity
- Compact 4.5" x 4.0" size
- -40°C to +85°C operation off the shelf
- Operating systems support for Windows 7 / XP and Linux 2.6 / 3.2 kernels

◆ Block Diagram

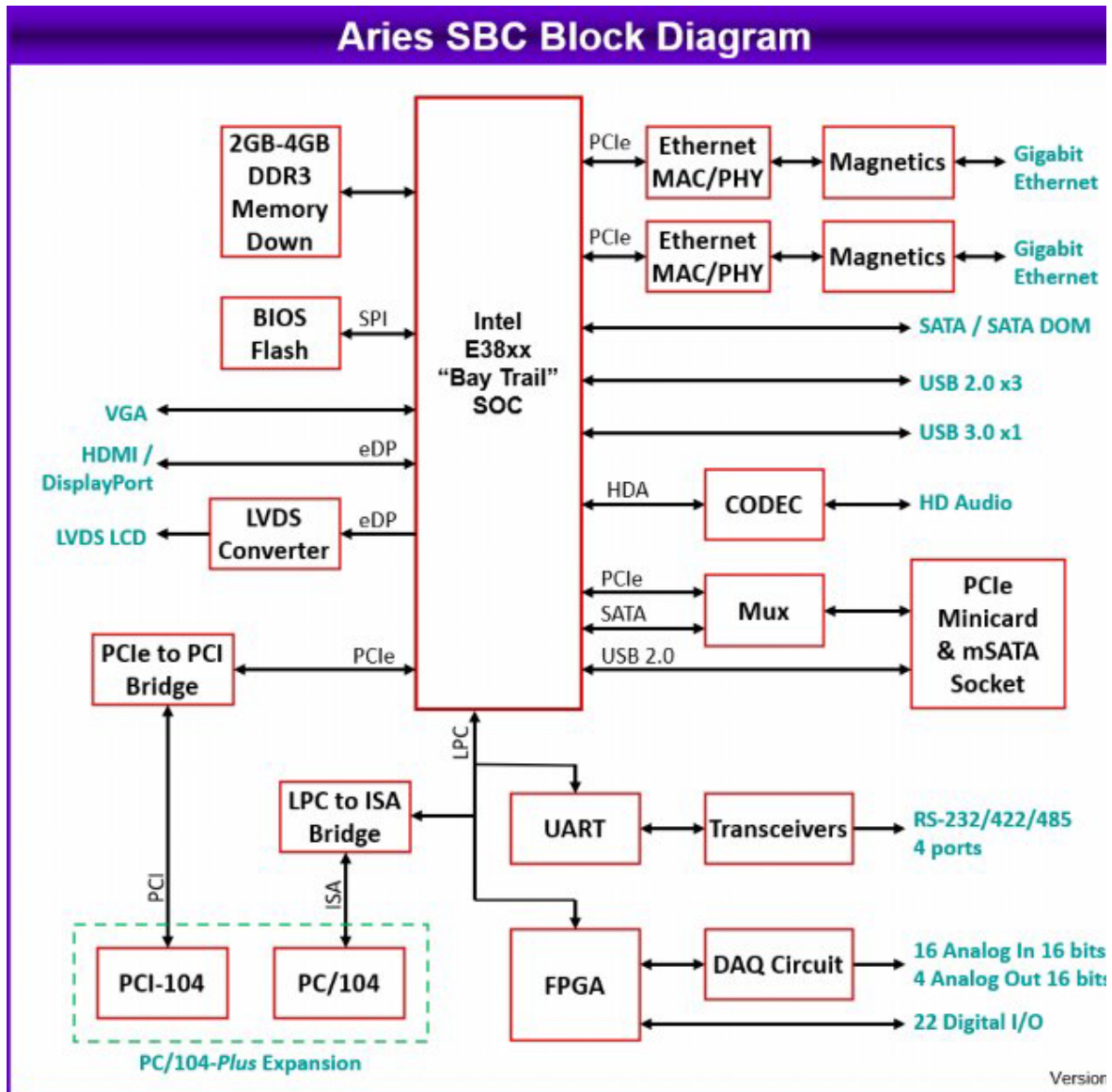

◆ Display Features

Aries supports dual simultaneous independent displays, selecting from VGA, LVDS LCD, and either HDMI or DisplayPort. (Both HDMI and DisplayPort are supported on board, however only one of these can be used at a time.)

The LVDS connection is dual channel 24-bit. The maximum resolution of VGA, LVDS and DisplayPort is 2560 x 1600. The HDMI maximum resolution is 1920 x 1080.

Backlight power and control are provided on board. LCD power is jumper selectable between 3.3V and 5V, and backlight power is jumper selectable between 5V and 12V. If needed, 12V must be provided by the system power supply and is routed through the board from the input power connector to the backlight connector.

◆ I/O Expansion

Aries provides both a PC/104-Plus expansion socket and a combination PCIe MiniCard / mSATA module socket. The combination socket auto-selects for either PCIe or mSATA depending on the type of module installed. Aries supports Diamond's complete line of **PCIe MiniCards**.

The SBC also supports the installation of a SATA disk-on-module with a mounting hole for increased ruggedness. A jumper provides power directly to the module through the single SATA connector; no separate power cable is required. Both the SATA DOM and PCIe MiniCard sockets can be used simultaneously, affording a highly compact and feature-rich embedded computing solution only one "board" high.

◆ Available Models

Four standard models are available depending on your need for performance and data acquisition. Other configurations are available by special order with a minimum order quantity.

Model	Processor /Speed	Memory	Data Acquisition
ARS3845-4GA	E3845/1.91GHz	4GB DDR3	Yes
ARS3845-4GN	E3845/1.91GHz	4GB DDR3	No
ARS3826-2GA	E3826/1.46GHz	2GB DDR3	Yes
ARS3826-2GN	E3826/1.46GHz	2GB DDR3	No

◆ Aries Development Kit

Development kits are available to enable quick evaluation of Aries with a variety of embedded operating systems, including Linux, Windows 7/10, and QNX. Development kits include an Aries SBC with data acquisition (model ARS3845-4GA), cable kit, and pre-programmed SATA DOM flashdisk that has the OS and demo applications on it. Simply install the SATA DOM onto Aries, apply cables and power, and boot up, and you have an Aries SBC running your choice of OS. Customization of BSPs to include additional drivers or features is available.

For more information about our QNX product and service offerings, please click [here](#).

◆ Cables

A cable kit is available to assist with the evaluation of Aries. The cable kit includes all cables except for:

- USB 3.0 (board uses industry standard cable)
- DisplayPort (board uses industry standard cable)
- HDMI (board uses industry standard cable)
- LCD (each LCD requires a custom cable; DSC can provide technical support for designing and building a cable for your LCD)

Individual cables are also available with minimum order quantity.

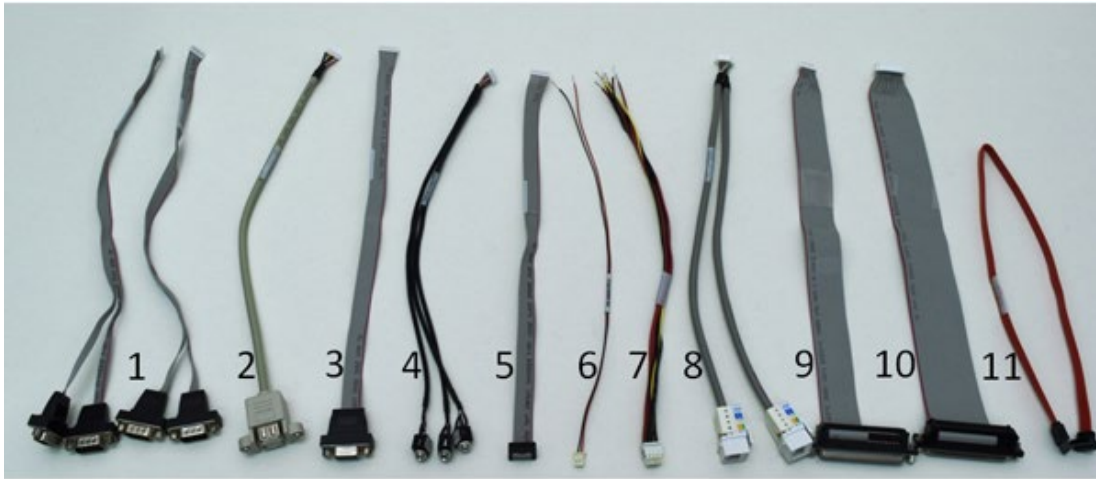

CK-ARS-03 includes the following cables:

No.	Qty	Cable	Description	Drawing
1	2	6980500	Cable 1.25mm to 2x DV9M Serial	Show
2	1	6980503	Cable, 2xUSB 2.0, 1.25 Con	Show
3	1	6980507	Cable, VGA, 1.25mm Con DE15 Female	Show
4	1	6981508	Ethernet Cable, 4 Ports, JST 32 Pin	Show
5	1	6980514	Cable, Utility, 2x6 2mm IDC Socket	Show
6	1	6980524	External battery cable, discrete wires	Show
7	1	6980512	Power input cable, discrete wires	Show
8	1	6980513	Cable, Dual Ethernet, 2x10 1.25mm	Show
9	1	6980517	Digital I/O cable, DB37F connector	Show
10	1	6980518	Analog I/O cable, DB37F connector	Show
11	1	6989101	SATA Cable, 7-Pin Data, Straight to Right Angle, 500mm	Show

◆ I/O Features

Aries incorporates a perfect combination of highly advanced I/O features, including 3 USB 2.0 ports and 1 USB 3.0 port, 4 programmable RS-232/422/485 ports, 2 10/100/1000 Mbps Ethernet ports, and 2 SATA ports.

A multi-use MiniCard socket auto-selects for either a PCIe MiniCard or mSATA flashdisk. This dual function socket can be used to add compact additional I/O or mass storage to your system. The dedicated SATA connector can be used with off-board SATA devices and also supports use of a board-mounted miniature SATA disk-on-module for a smaller overall system envelope with less cables.

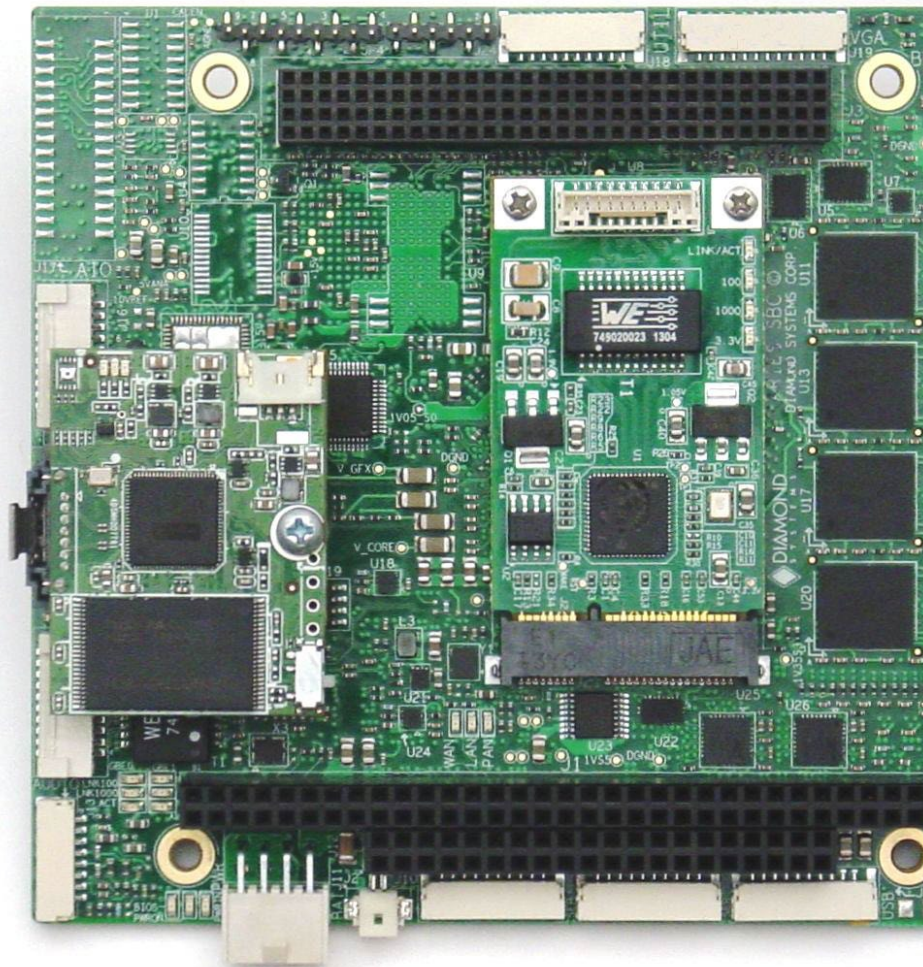

Aries provides 4 RS-232/422/485 ports using multiprotocol transceivers, one per port. All configuration features are fully programmable as well as configurable in the BIOS screens, including protocol and line termination for RS-422/485. In RS-422 mode, both half duplex and full duplex line termination can be selected.

Aries supports two 10/100/1000 high speed Gigabit Ethernet ports derived from Intel I210IT PCIe Gigabit Ethernet controllers. A latching connector is used to bring these ports off board instead of RJ-45 jacks, optimizing space on the board and increasing ruggedness. Activity status of the Ethernet ports can be read from LEDs.

Aries includes miniature rugged latching connectors for most I/O, including LVDS LCD, as shown in the photo below. Latching connectors improve the ruggedness of the SBC, enhancing Aries' performance in harsh environments.

◆ Rugged Features

The Aries family includes a full set of rugged design features to enable reliable use in vehicle, wide temperature, high vibration, and other harsh environments:

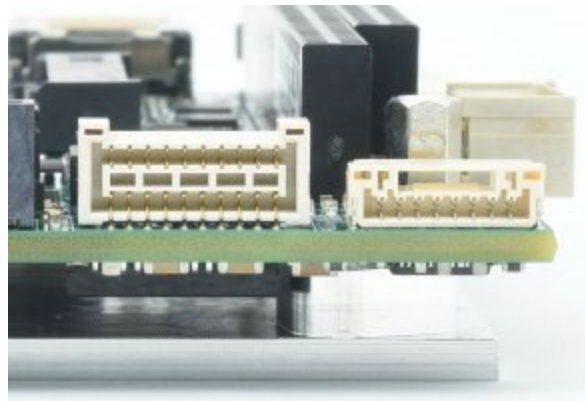

- Aries is designed and built with industrial range temperature components and wide temperature design considerations. The board has been tested and qualified for use in temperatures ranging from -40°C to +85°C. All models feature wide temperature operation off the shelf with no pre-screening required.
- A thicker PCB of 2.4mm (shown above) increases rigidity and enhances long-term reliability.
- All I/O connectors, except HDMI, DisplayPort, and USB 3.0, provide positive locking connections for confident performance in vehicle or other high vibration environments.
- Aries is compatible with MIL-STD-202-G shock and vibration test requirements.
- The system memory is soldered on board for increased ruggedness, eliminating potential failures often associated with SO-DIMM sockets and improving high temperature reliability.
- For custom configurations, all jumpers can be replaced with 0 ohm resistors soldered into dedicated locations on the board. In addition, the number of jumpers has been reduced by offering software configuration of all serial port features.
- Aries can operate over the full industrial temperature range of -40°C to +85°C without a fan, due to its use of an integrated bottom-mounted heat spreader for effective cooling. The heat spreader contacts the bottom-mounted processor, memory, and other key heat producing components and provides efficient heat transfer from these ICs to the mounting surface (enclosure wall). A traditional

0.5" high heat sink accessory is available for applications that require a non-contact installation method.

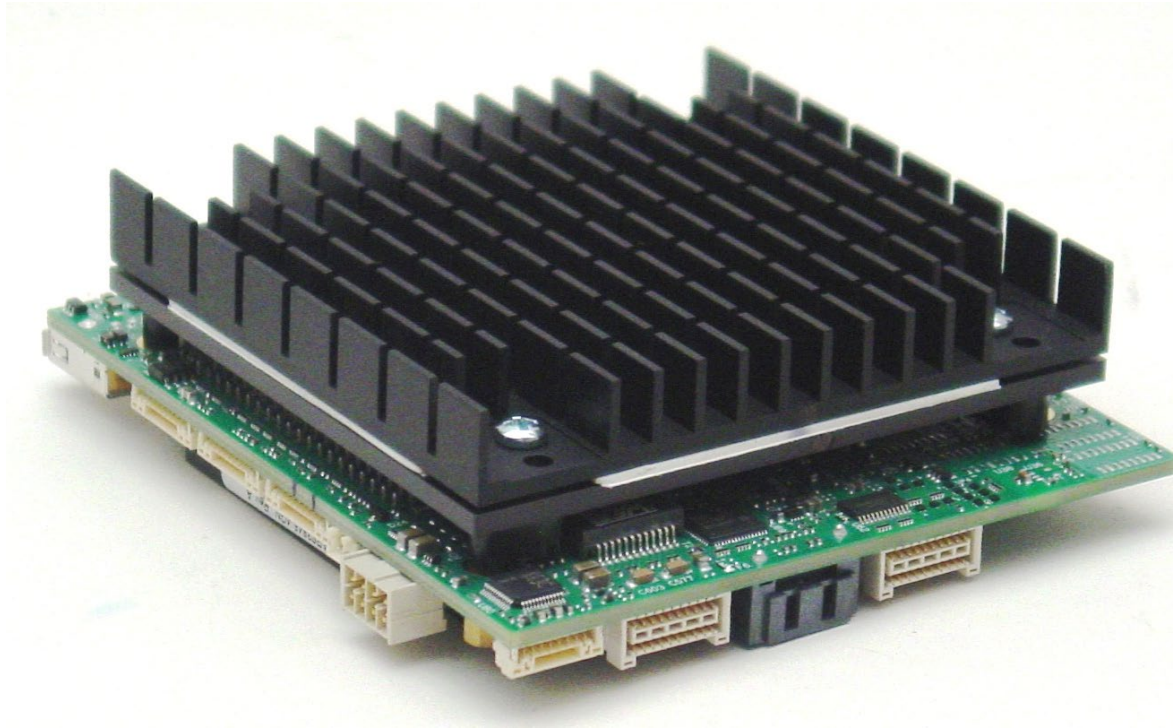

Aries SBC with heat sink accessory

◆ **Integrated Data Acquisition**

Aries is available with a complete analog and digital data acquisition (DAQ) circuit integrated onto the board. The features of the Aries DAQ circuit surpass those found on most other embedded SBCs to provide a comprehensive, professional quality subsystem backed with top of the line software support. "A" models include the full DAQ circuit with both analog and digital I/O features, while "N" models include only the digital I/O features.

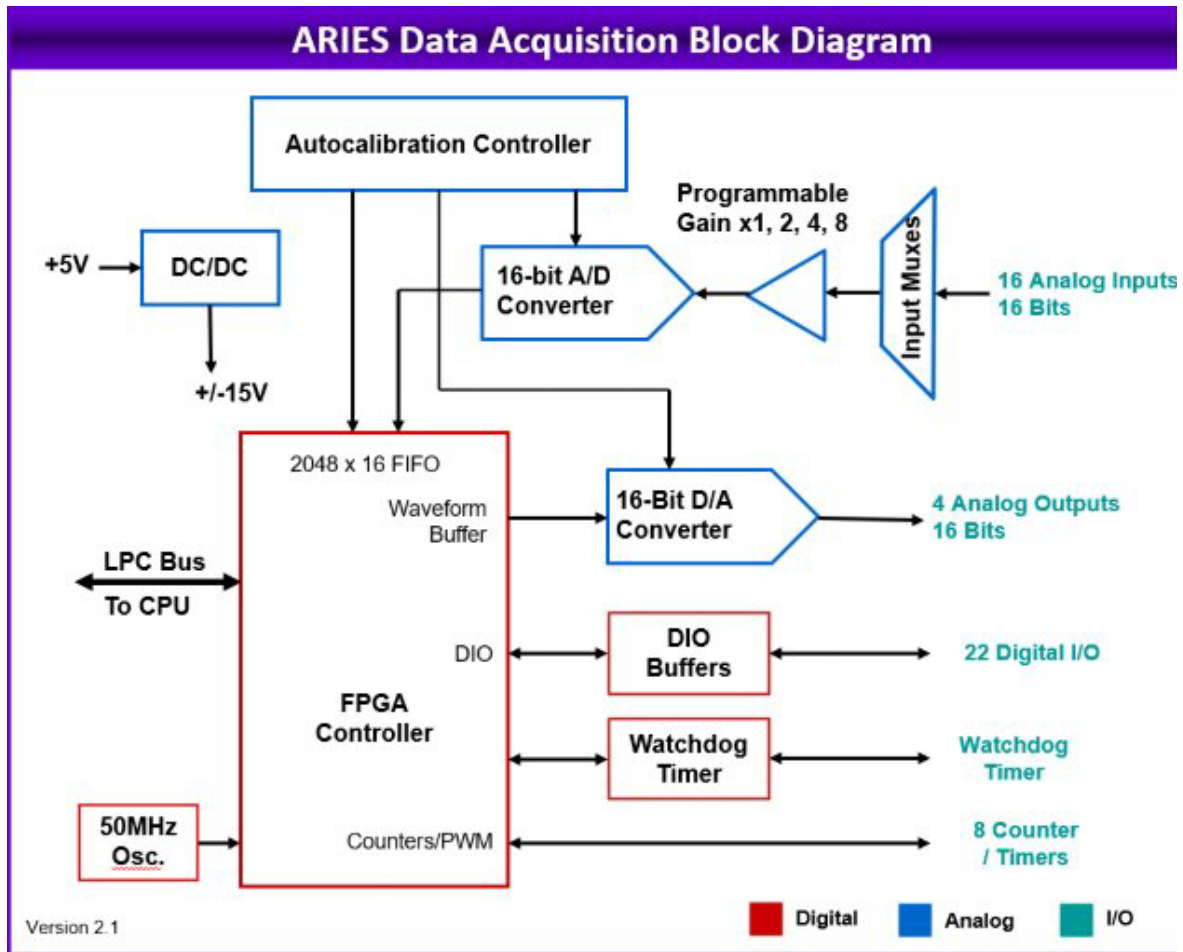

◆ Feature Details

The A/D circuit includes 16 single-ended / 8 differential analog input channels with programmable input ranges and a maximum aggregate sampling rate of 250KHz. A built-in programmable counter/timer supports accurate high-speed sampling with precise timing. The 2048-sample FIFO with programmable threshold ensures error-free sampling and enables you to tune the performance of the circuit to minimize interrupt processing overhead.

The D/A circuit consists of 4 16-bit D/A voltage outputs with independently programmable output ranges including 0-10V, +/-10V, 0-5V, and +/-5V. A 2048-sample waveform buffer is included to support arbitrary waveform generator functions on up to 4 channels simultaneously.

The digital I/O circuit consists of GPIO, counter/timers, and pulse-width modulators. The GPIO circuit provides 22 buffered digital I/O lines, consisting of one 8-bit port and 14 1-bit ports. Each port is individually programmable for input or output. The 1-bit direction controllable ports provide better matching of input and output quantities to each application. Jumper configuration enables selection of 5V/3.3V logic levels and pull-up or pull-down resistors on the digital I/O lines.

The 8 32-bit programmable counter/timers feature both up and down counting with clocking selectable from an external digital signal or the on-board 50MHz clock. Counters can be used for generating programmable output frequencies with programmable output pulse widths, counting external events, generating interrupts to the host processor at a

programmable rate, and driving A/D sampling at precise frequencies with perfect timing between samples.

The circuit further includes 4 24-bit programmable pulse width modulators also driven by the on-board 50MHz clock. These feature programmable rate, duty cycle, and polarity, with real-time rate and duty cycle update capability.

◆ Software Support

Diamond System's **Universal Driver software** provides unmatched power and flexibility for embedded data acquisition programming with PC/104 and small form factor I/O boards. It provides flexible C-language programming support for Windows and Linux to control all data acquisition features on Aries, as well as Diamond's PC/104 and PCIe MiniCard data acquisition modules that can be used with Aries.

A powerful and convenient graphical control panel provides instant, easy access to all data acquisition features on the

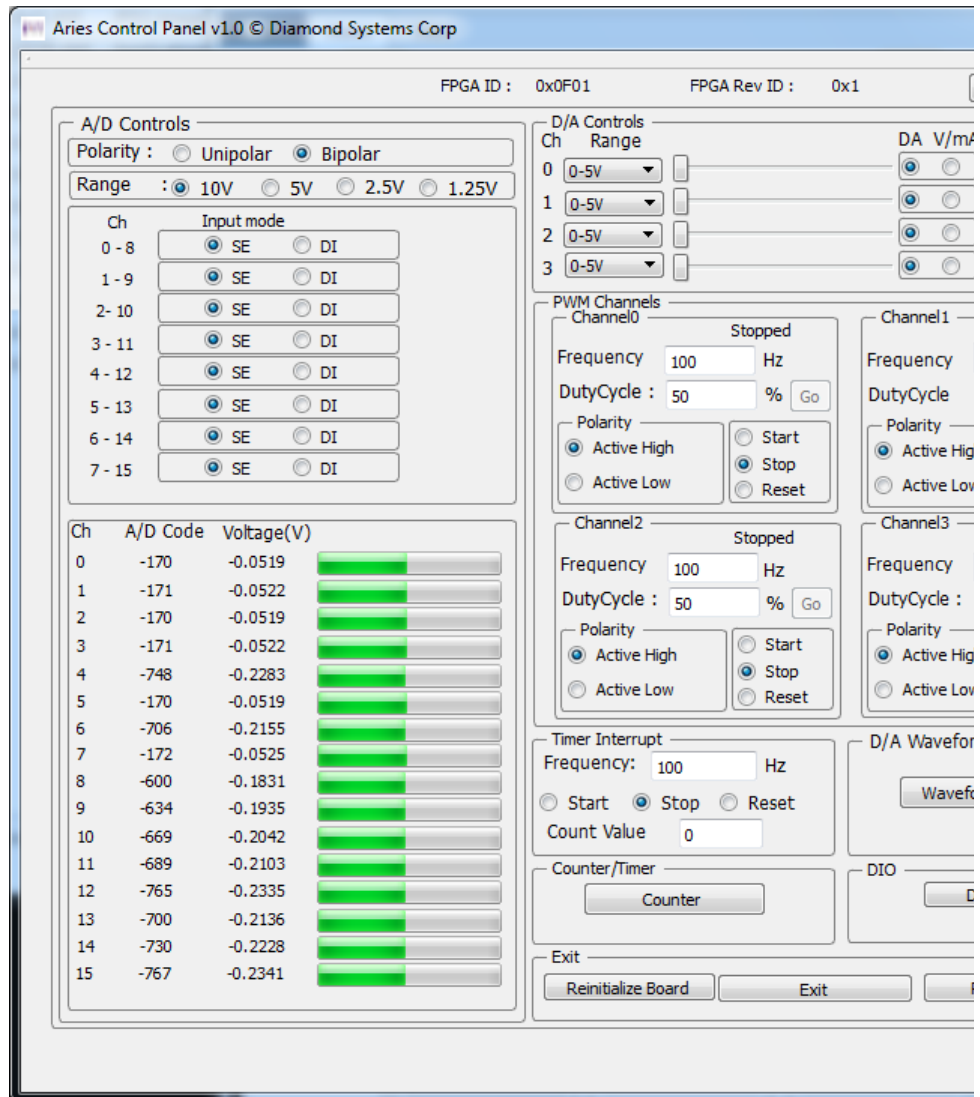

board. It can be used for proof of concept, testing, and even system debugging.

Click on the following link to download Diamond System' **Universal Driver software** for the Aries SBC.

Specifications

Core System Functions

Processor	1.91GHz Intel quad core E3845 CPU or 1.46GHz Intel dual core E3826 CPU
Memory	2GB or 4GB on-board DDR3 SDRAM
BIOS	AMI PnP Flash BIOS

I/O Interfaces

Mass Storage	1 SATA port, supports 1 external device or SATA-DOM mSATA flashdisk socket supports up to 64GB
Serial	4 RS-232/422/485 ports
USB	3 USB 2.0 ports & 1 USB 3.0 port
Networking	2 Gigabit Ethernet ports
Keyboard/Mouse	USB keyboard/mouse
Display	Dual independent displays for any two of the following: 24-bit LVDS LCD flat panel interface VGA CRT interface DisplayPort or HDMI (cannot be used simultaneously)
Display Resolution	VGA, LVDS & DisplayPort: 2560 x 1600 maximum resolution HDMI: 1920 x 1080 maximum resolution
Audio	ALC892 Codec HD audio with stereo line-out, line-in & microphone
Watchdog timer	Programmable timeout from 0 to 255 seconds

Data Acquisition Features

Analog Inputs	16 single-ended or 8 differential, user selectable
A/D Resolution	16 bits
Input ranges	±10V, ±5V, ±2.5V, ±1.25V, 0-10V, 0-5V, 0-2.5V programmable
Max Sample Rate	250KHz
Protection	±35V on any analog input without damage
Nonlinearity	±3LSB, no missing codes
On-board FIFO	2048 samples, programmable threshold
A/D and D/A Calibration	Autocalibration with software support
Analog Outputs	4, 16-bit resolution
Output ranges	±5V, ±10V, 0-5V, 0-10V programmable
Input impedance	10 ¹³ ohms
Output current	±5mA max per channel

Settling time	10µS max to 0.012%
Relative accuracy	±2 LSB
Nonlinearity	±2 LSB, monotonic
Reset	Reset to zero-scale or mid-scale (jumper selectable)
Digital I/O lines	22 programmable direction consisting of 1 8-bit port and 14 1-bit ports
Input voltage	Logic 0: 0V min, 0.8V max Logic 1: 2.0V min, 5.5V max
Input current	1µA at 3.3V, -5µA at 0V
Output voltage	Logic 0: 0.0V min, 0.55V max Logic 1: 2.0V min, 3.3V max
Output current	Logic 0: 64mA max at 0.55V Logic 1: 32mA max at 2V
Waveform generator	4 channel, 2048 x 18-bit buffer
Pulse width modulators	4 24-bit programmable
Counter/timers	8 32-bit

Expansion Buses

PC/104-Plus	(ISA + PCI) stackable I/O
PCIe MiniCard	1 socket

Physical and Mechanical

Power Input	+5VDC ±5%
Power Consumption	E3845 CPU: 8.5W E3826 CPU: 8.0W
Operating Temperature	-40°C to +85°C (-40°F to +185°F)
Operating Humidity	0-90% non-condensing
Shock	MIL-STD-202G compatible
Vibration	MIL-STD-202G compatible
Form Factor	PC/104-Plus
Dimensions	4.5 x 4.0 in. (114 x 102 mm)
Weight	8.6 oz (243.8g) with heat spreader
MTBF	150,240 hours at 20°C
RoHS	Compliant

◆ Models and Accessories

Aries		
available models:		
ARS3845-4GA	Aries SBC, 1.91GHz E3845 CPU, 4GB DDR3 SDRAM, analog I/O & digital I/O	Available
ARS3845-4GN	Aries SBC, 1.91GHz E3845 CPU, 4GB DDR3 SDRAM, digital I/O	Available
ARS3826-2GA	Aries SBC, 1.46GHz E3826 CPU, 2GB DDR3 SDRAM, analog I/O & digital I/O	EOL
ARS3826-2GN	Aries SBC, 1.46GHz E3826 CPU, 2GB DDR3 SDRAM, digital I/O	EOL
DK-ARS-WE7	Aries Development Kit with ARS3845-4GA SBC, cables and Windows Embedded 7 OS	Available
SDK-ARS-WE7	Aries Windows Embedded 7 Software Development Kit	Available
DK-ARS-LNX	Aries Development Kit with ARS3845-4GA SBC, cables and Linux OS	Available
SDK-ARS-LNX	Aries Linux Software Development Kit	Available
DK-ARS4GA-QNX70-32	QNX 7.0 Development Kit for Aries SBC, includes Aries board, cable kit, QNX OS on flashdisk	Available

SDK-ARS-QNX70-32	QNX 7.0 Software Development Kit for Aries SBC, Includes QNX OS on flashdisk	Available
ACC-HS104-12.7	Heat Sink Accessory	Available

Please [login](#) or [signup](#) for an online quote request.

Cables and accessories

available models:

FDSM-32G-XT	SATADOM Flashdisk, MLC, 32GB, Pin 7 VCC, -40/+85C
FDSM-64G-XT	SATADOM Flashdisk, MLC, 64GB, Pin 7 VCC, -40/+85C
FDSS-32G-XT	SATADOM Flashdisk, SLC, 32GB, Pin 7 VCC, -40/+85C
FDSS-64G-XT	SATADOM Flashdisk, SLC, 64GB, Pin 7 VCC, -40/+85C
FDMM-16G-XT	mSATA MLC Flashdisk, 16GB, extended temperature
FDMM-32G-XT	mSATA MLC Flashdisk, 32GB, extended temperature
FDMM-64G-XT	mSATA MLC Flashdisk, 64GB, extended temperature
FDMS-16G-XT	mSATA SLC Flashdisk, 16GB, extended temperature
FDMS-32G-XT	mSATA SLC Flashdisk, 32GB, extended temperature
FDMS-64G-XT	mSATA SLC Flashdisk, 64GB, extended temperature
CK-ARS-03	Aries Cable Kit
6980500	Cable 1.25mm to 2x DV9M Serial
6980503	Cable, 2xUSB 2.0, 1.25 Con
6980507	Cable, VGA, 1.25mm Con DE15 Female
6981508	Ethernet Cable, 4 Ports, JST 32 Pin
6980514	Cable, Utility, 2x6 2mm IDC Socket
6980524	External battery cable, discrete wires
6980512	Power input cable, discrete wires
6980513	Cable, Dual Ethernet, 2x10 1.25mm
6980517	Digital I/O cable, DB37F connector
6980518	Analog I/O cable, DB37F connector
6989101	SATA Cable, 7-Pin Data, Straight to Right Angle, 500mm

Please [login](#) or [signup](#) for an online quote request.

www.diamondsystems.com | [Sunnyvale, California USA](#) | [+1-650-810-2500](tel:+16508102500) | sales@diamondsystems.com